



Nuova Remital srl

Produzione Aspiratori-Soffianti a canale laterale

DATA SHEETS MODEL R33 Monophase

ASPIRAZIONE / VACUUM Hz. 50

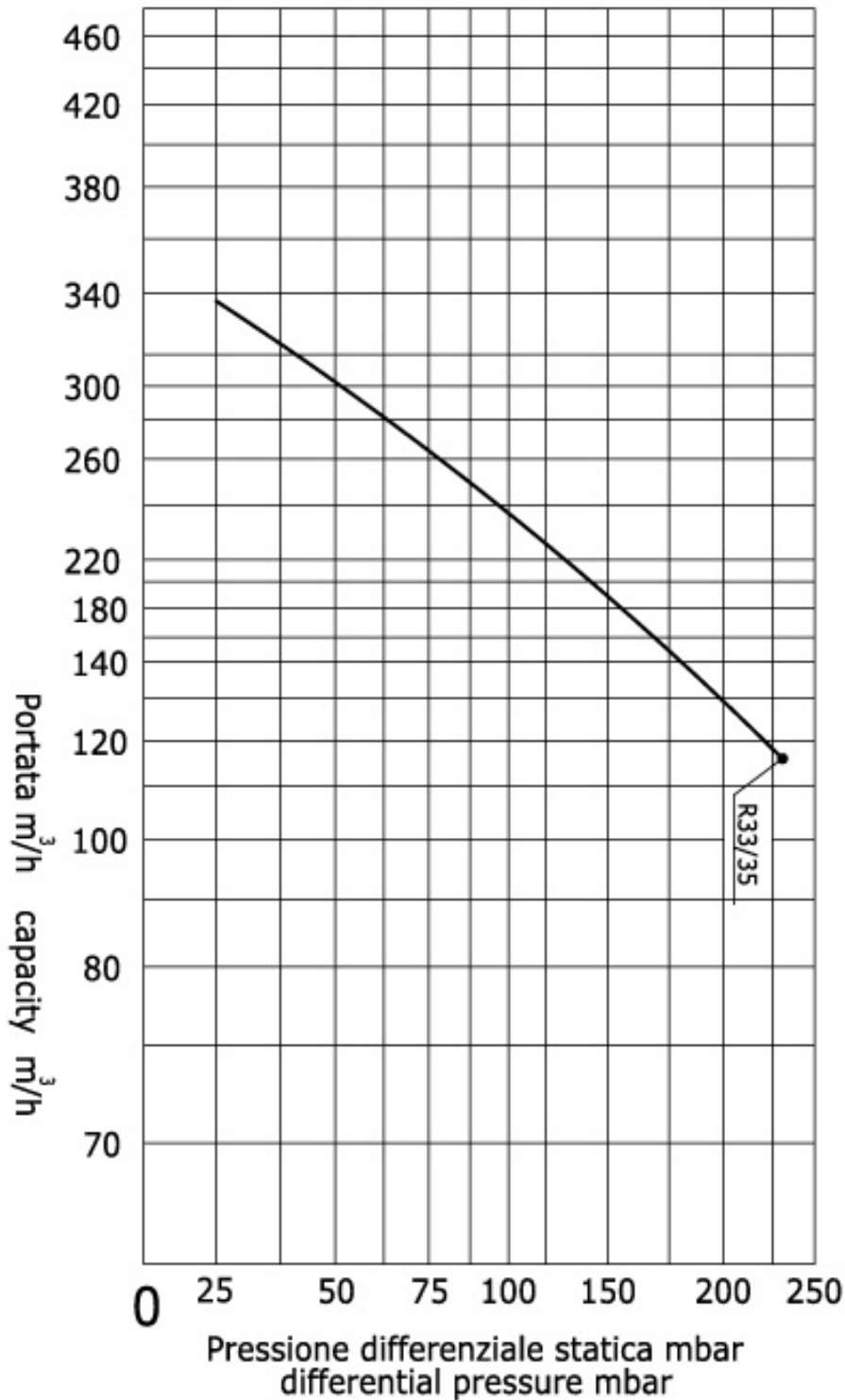



Nuova Remital srl

Produzione Aspiratori-Soffianti a canale laterale

DATA SHEETS MODEL R33 Monophase

ASPIRAZIONE / VACUUM Hz. 50

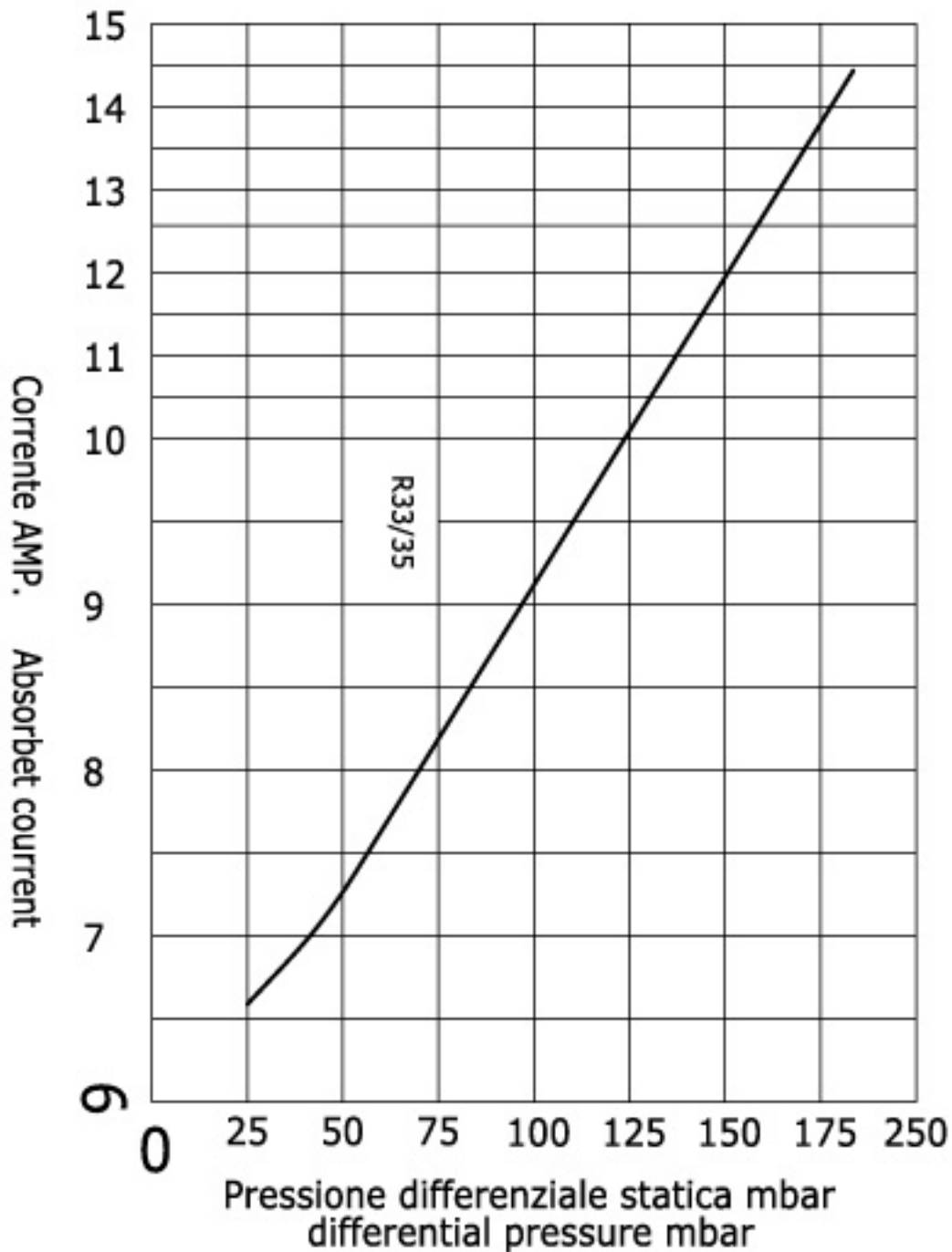



Nuova Remital srl

Produzione Aspiratori-Soffianti a canale laterale

DATA SHEETS MODEL R33 Monophase

ASPIRAZIONE / VACUUM Hz. 50

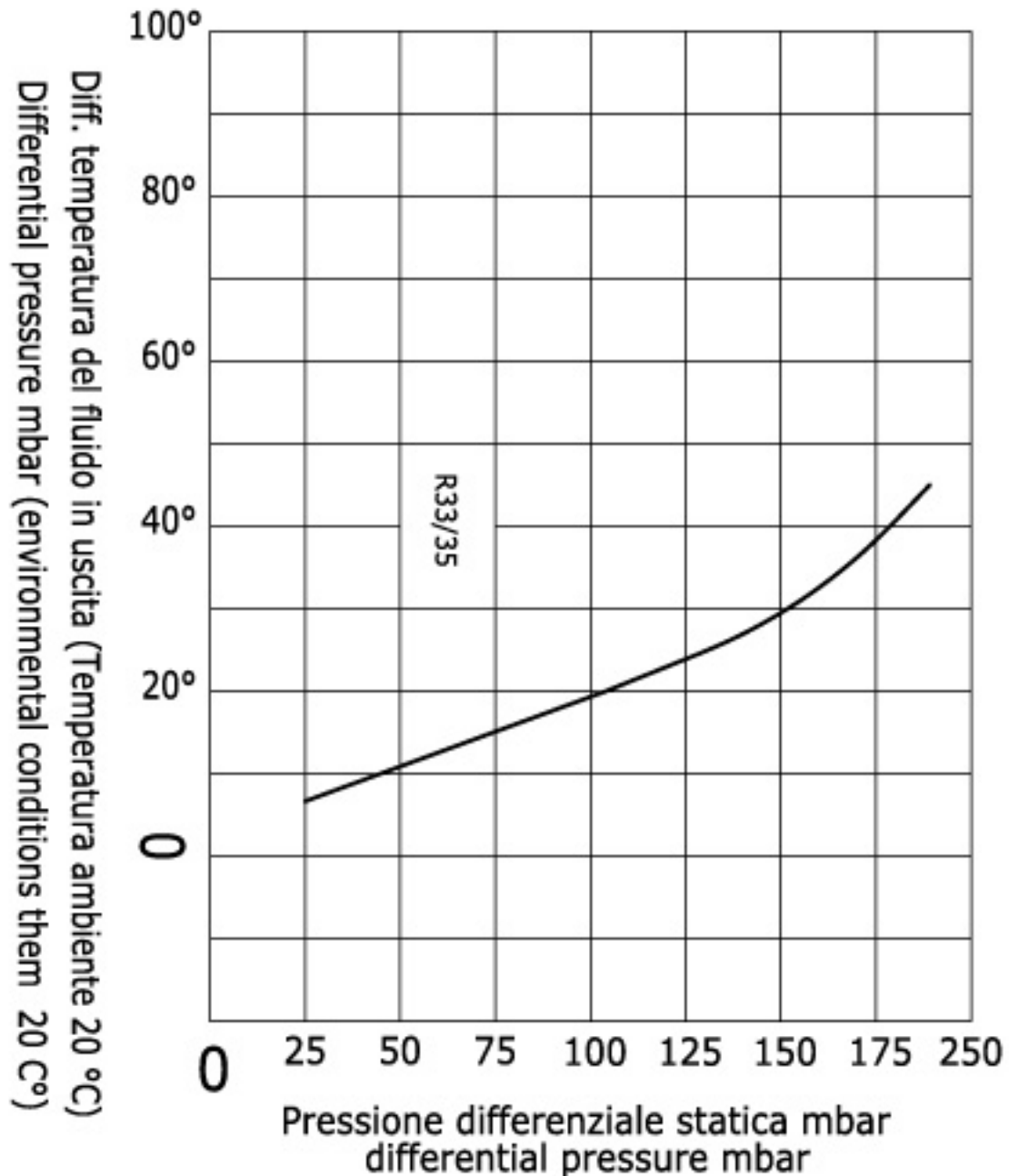



Nuova Remital srl

Produzione Aspiratori-Soffianti a canale laterale

DATA SHEETS MODEL R33 Monophase

COMPRESSIONE / COMPRESSION Hz. 50

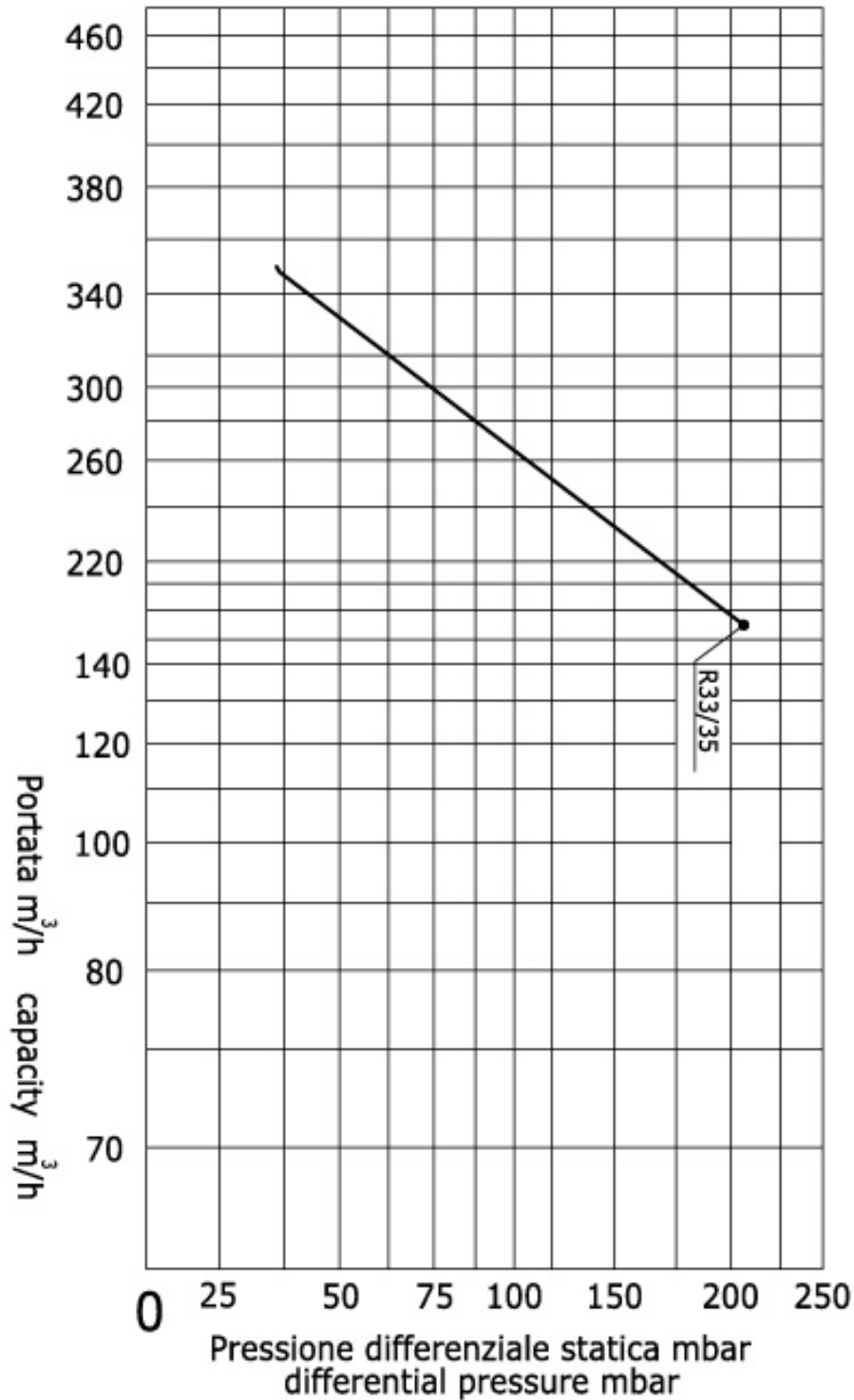



Nuova Remital srl

Produzione Aspiratori-Soffianti a canale laterale

DATA SHEETS MODEL R33 Monophase

COMPRESSIONE / COMPRESSION Hz. 50

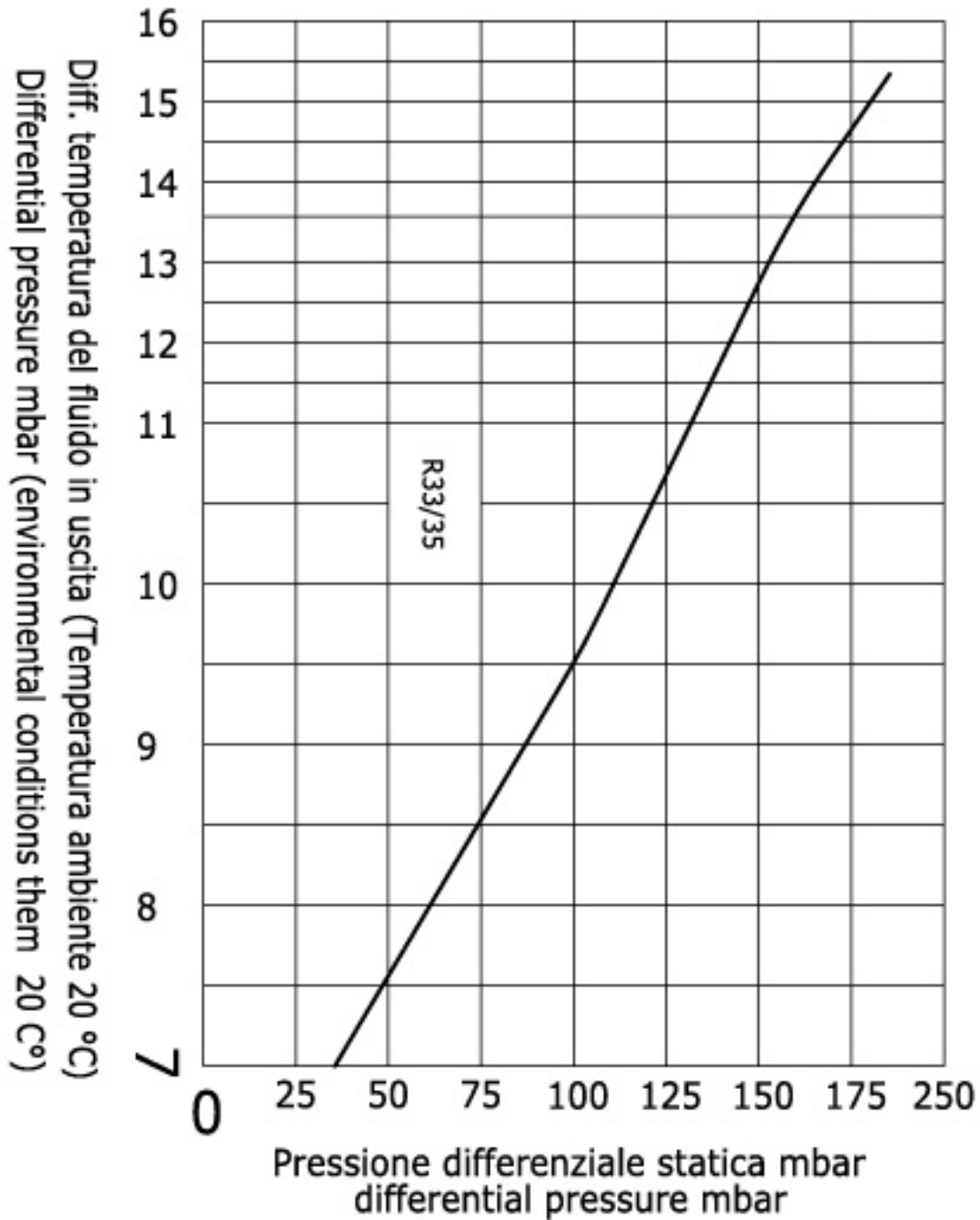



Nuova Remital srl

Produzione Aspiratori-Soffianti a canale laterale

DATA SHEETS MODEL R33 Monophase

COMPRESSIONE / COMPRESSION Hz. 50

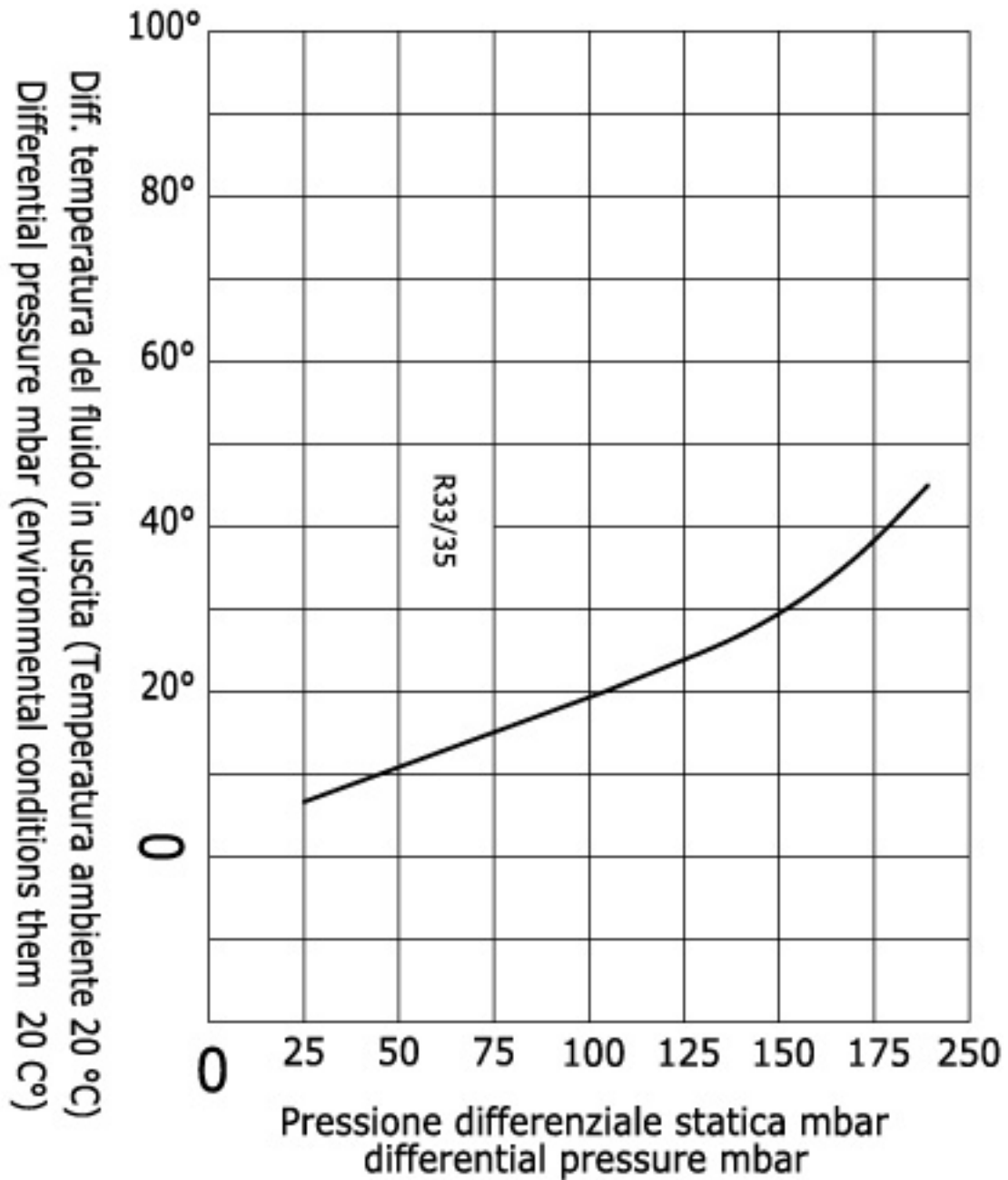



Nuova Remital srl

Produzione Aspiratori-Soffianti a canale laterale

DATA SHEETS MODEL R33 Monophase

INGOMBRI / DIMENSIONS

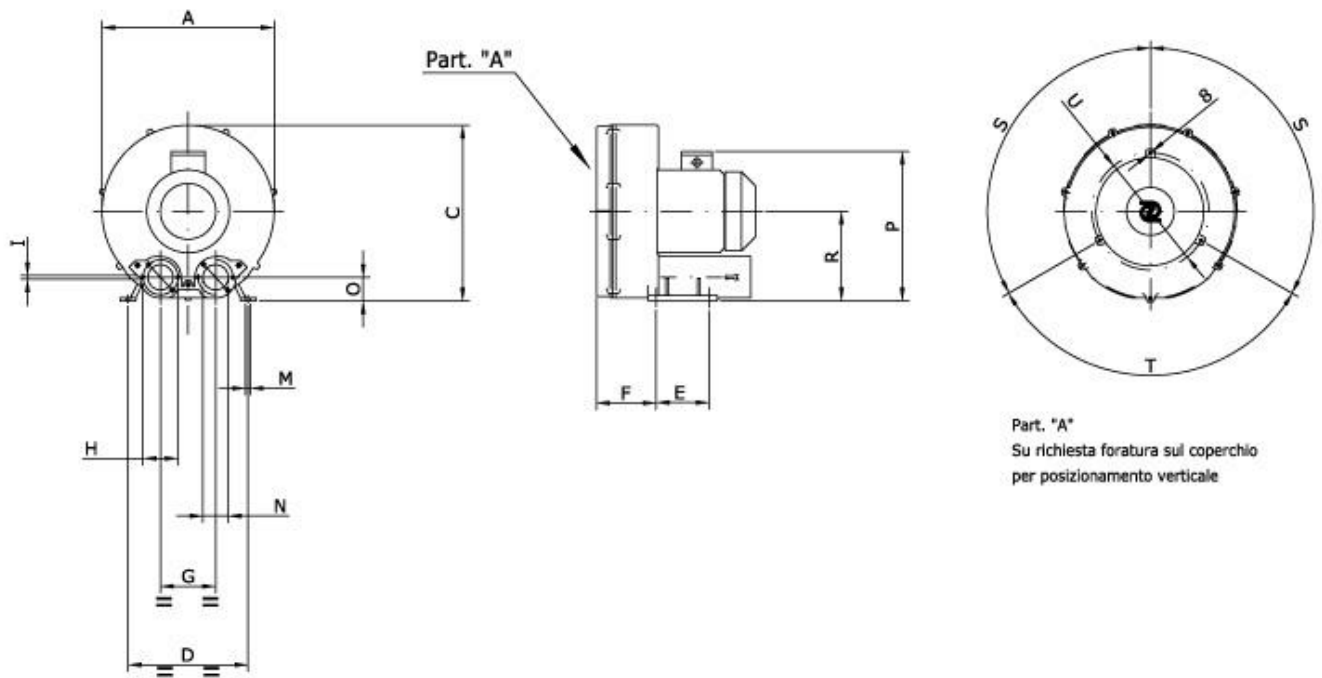

<i>Tipo/Type</i>	<i>Quote/Dimensions</i>																		
<i>MODELLO R-3</i> <i>MODEL R-3</i>	A	B	C	D	E	F	G	H	I	L	M	N	O	P	R	S	T	U	PESO Kg.
<i>Art. R-33/....</i>	375	376	382	260	115	130	120	83	M8	47°	15	55	50	324	194	120	120	254	28

Nuova Remital srl si riserva il diritto di apportare modifiche senza preavviso / reserves the right to make changes without prior notice